

# SB7248 – ICON SHOWER PANS

72 x 48 x 3 inches



## FEATURES

- ArmorCore™ slip resistant, textured bottom
- Center drain
- Low 3" threshold
- Integrated weep holes
- Sloped threshold ensures water containment
- Pre-leveled legs, no mortar bed required
- Sleek minimalist design
- AcrylX™ applied acrylic surface
- Lifetime limited warranty

## OPTIONS

- Brass drain assembly and cover

## COLOR OPTIONS

Standard

White



PRAXIS



# SB7248

72 x 48 x 3  
inches

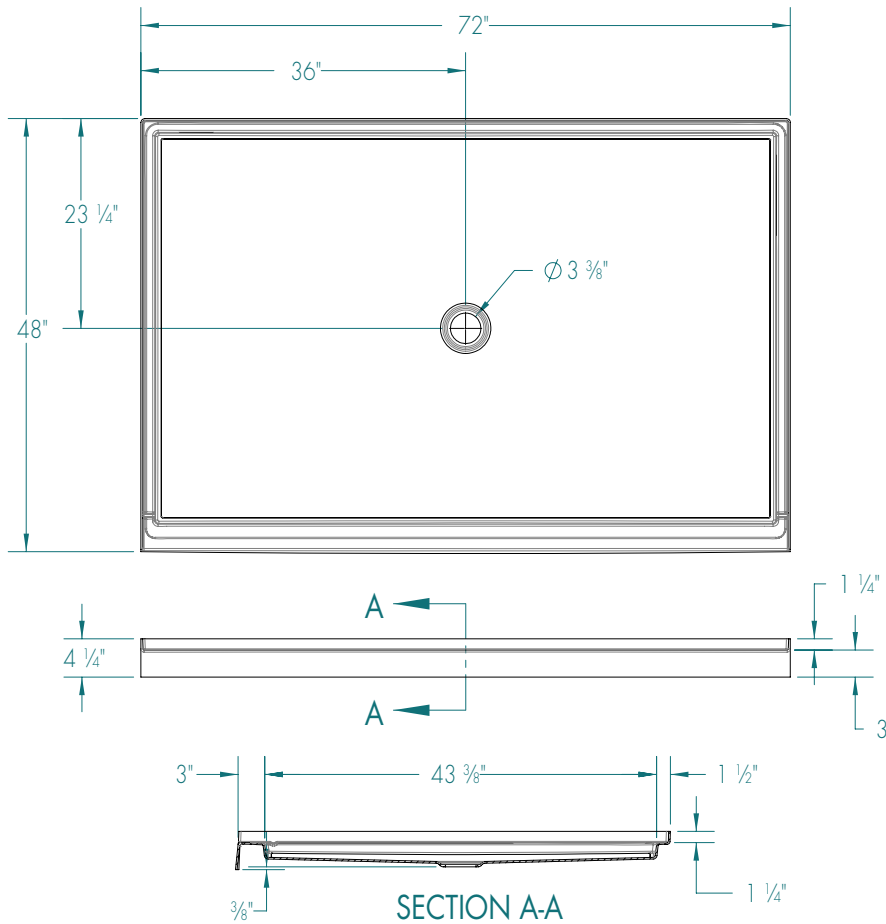

**FEATURES** Dimensional Tolerance  $\pm 3/64"$ . Dimensions needed for site preparation should be measured from the unit. Manufacturer assumes no responsibility for preparatory work.

Model #	Material	Drain	Net Wt. lbs.	Pkg. Wt. lbs.
Shower Pan #SB7248	AcrylX™	Center	119	—

## DIMENSIONS

Specifications	inches
<b>Width:</b> Overall / Net	72
<b>Depth:</b> Overall / Net	48
<b>Height:</b> Overall / Net	4 1/4 / 3
<b>Enclosure Opening</b>	—
<b>Skirt Height</b>	3
<b>Drain Rough-In</b> (from Back Wall)	23 1/4
<b>Drain Rough-In</b> (from Side Wall)	36
<b>Drain:</b> Diameter / Clearance	3 3/8 / 3/8

## FRAMING DIMENSIONS inches

Type	D Depth	W Width	H Height	A	B	C
Alcove	48	72	—	Box Out	36	23 1/4

