

RH6 “St. Croix” PRODUCT MANUAL



IMPORTANT SAFETY INSTRUCTIONS

PERTAINING TO A RISK OF FIRE, ELECTRIC SHOCK, FETAL INJURY, DROWNING, HYPERTHERMIA, OR INJURY TO PERSONS

READ AND FOLLOW ALL INSTRUCTIONS



WARNING: RISK OF FETAL INJURY; Pregnant or possibly pregnant women should consult a Physician before using a hydromassage bathtub equipped with a heater.



WARNING: RISK OF ELECTRIC SHOCK.

- The unit must be connected to a supply circuit that is protected by a Ground-Fault Circuit-Interrupter (GFCI) installed by a qualified service representative or Licensed Electrician.
- Install this unit in accordance with the Canadian Electric Code, part I. the control provided with this unit shall be installed out of reach of persons occupying the tub in accordance with the Canadian Electrical Code , part I "*for unit with a control not integral with the tub.*"
- Do not permit electrical appliances (such as a hair dryer, lamp, telephone, radio, or television) within 5 feet or 1.5 meters of this hydromassage bathtub.
- GFCI should be tested on a routine basis. To test the GFCI, push the test button. The GFCI should interrupt power. Push the reset button. Power should be restored. If the GFCI fails to operate in this manner, the GFCI is defective. If the GFCI interrupts power without the test button being pushed there is ground current flowing, indicating the possibility of an electric shock. Do not use this hydromassage bathtub. Disconnect the hydromassage bathtub and have the problem corrected by a qualified service representative or Licensed Electrician before using.



WARNING: RISK OF ACCIDENTAL INJURY AND DROWNING;

- Children should not use hydromassage bathtub without adult supervision.
- Do not use hydromassage bathtub unless all suction guards are installed to prevent body hair entrapment.
- Do not use drugs or alcohol before or during the use of the hydromassage bathtub equipped with heater to avoid unconsciousness and possible drowning.
- Do not use a hydromassage bathtub equipped with a heater immediately following strenuous exercise.
- Water temperature in excess of 100° Fahrenheit or 38° Celsius may be hazardous to your health. Check and adjust water temperature before use.
- Prolonged immersion in water hotter than normal body temperature may introduce hyperthermia.
- People using medications and/or having an adverse medical history should consult a Physician before using a hydromassage bathtub equipped with a heater.



WARNING: RISK OF HYPERTHERMIA

- Do not use a hydromassage bathtub equipped with a heater immediately following strenuous exercise.
- Water temperature in excess of 100° Fahrenheit or 38° Celsius may be hazardous to your health. Check and adjust water temperature before use.
- Prolonged immersion in water hotter than normal body temperature may introduce hyperthermia.
- Symptoms of Hyperthermia;
 - Heat stroke can be life-threatening and victims can die. A person with heat stroke usually has a body temperature above 104° Fahrenheit. Other symptoms include confusion, combativeness, bizarre behavior, faintness, staggering, strong and rapid pulse, and possible delirium or coma. High body temperature is capable of producing irreversible brain damage.
 - Heat fatigue is a feeling of weakness brought on by high outdoor temperature. Symptoms include cool, moist skin and a weakened pulse. The person may feel faint.
 - Heat syncope is a sudden dizziness experienced after exercising in the heat. The skin appears pale and sweaty but is generally moist and cool. The pulse is weakened and the heart rate is usually rapid. Body temperature is normal.
 - Heat cramps are painful muscle spasms in the abdomen, arms, or legs following strenuous activity. Heat cramps are caused by a lack of salt in the body.
 - Heat exhaustion is a warning that the body is getting too hot. The person may be thirsty, giddy, weak, uncoordinated, nauseated and sweating profusely. The body temperature is normal and the pulse is normal or raised. The skin is cold and clammy.



WARNING: Do not permit children to use this unit unless they are closely supervised at all times.



WARNING: Exercise care when entering or exiting the hydromassage bathtub.



WARNING: Use this unit only for its intended use as described in this manual. Do not use attachments unless recommended by the manufacturer.



WARNING: Do not drop or insert any objects into any openings.



WARNING: Do not operate this unit without the guard over the suction fitting.



WARNING: Service or repair work needed for this hydromassage bathtub other than normal cleaning or care should be performed by an authorized and qualified service representative.

SAVE THESE INSTRUCTIONS

This manual is intended to ensure that the equipment performs to your satisfaction. The following information is crucial to the proper operation of the equipment, and will allow for a great bathing experience for both the caregiver and the one being cared for.

If there are any questions during the installation or operation of this unit, please contact the Authorized Dealer or Distributor from whom the Product was purchased.



This symbol is used throughout this manual to highlight items of importance or safety. Please pay particular attention to these items to ensure proper and safe operation of equipment.

Table of Contents

Technical Specifications.....	Section 1
Using the Tub.....	Section 2
Pre-Installation and Dimensions.....	Section 3
Installing the Tub.....	Section 4
Warranty and Disclaimer.....	Section 5
Maintenance and Adjustments.....	Section 6
Troubleshooting.....	Section 7
Parts	Section 8

Technical Specifications

Description: Model RH6 is a freestanding or built-in, 60-gallon side access bathing tub.

Construction: The tub shell consists of a 3/16" thick fiberglass-reinforced polyester laminate. Critical areas are reinforced with a 1/4" thick core of end-grain balsa and additional layers of fortifying laminate. The sanitary gelcoat is an ISO/NPG type-finish. The tub frame is welded aircraft grade aluminum box tube.

Side Access Door: The water tight outward swing door has a compression-type seal.

Front Access Panel: The front access panel can be removed allowing access to the drain, legs, whirlpool motor, plumbing, and air spa motor.

Drain and Overflow Assembly: An ample 1 1/2" drain is installed with an overflow.

Hand-Held Shower: A chrome, hand-held shower wand with a flexible hose retracts out of site and is mounted to the deck of the tub.

Contour Grab Bars: Two 7 1/2" white contoured grab bars securely mounted on the interior and door of the tub.

Leveling Legs: The sturdy stainless steel leveling legs will adjust up to 2" per leg.

Air Spa (if equipped): The Air Spa System is a hygienic and low maintenance hydromassage system featuring 12 air jets with spring loaded check valves for back flow prevention, which prevents water from entering the air lines. Unlike most other whirlpool and air spa systems, the Air Spa System does not allow water to enter the air lines, which may become a breeding-ground for bacteria and mold. The Air Spa System is a highly efficient hydromassage system that simplifies disinfection and reduces the possibility of cross-contamination. The motor is quiet, efficient, and has a ceramic heating element that blows warm air to help maintain the water temperature and warm the surface of the tub.

Whirlpool (Supreme models): The whirlpool system has 8 jets and a 1-horsepower pump with a pneumatic actuator switch and air control dial. The pump is quiet, efficient, and has a ceramic heating element that warms the water to help maintain the temperature.

Chromatherapy (Supreme models): Is a surface mounted high brightness LED light that produces 7 different colors designed to stimulate physical, psychological, and emotional responses.

Aromatherapy (Supreme models): Diffuses the natural aroma of essential oils into the ambient air, which induces a state of relaxation, well-being, and relief.

PERFORMANCE DATA:

Water Capacity (unoccupied): 60 Gallons / 227.1 L

Fill-Time (approx.): 5 minutes

Drain Time (approx.): 2 minutes

Weight Capacity (occupant): 400 lbs. / 181.8 kg

SERVICE CONNECTIONS:

Drain: 1 1/2" PVC outlet

Electrical: 115V AC, 60Hz, 15A (GFCI outlet required)

Water Supply Inlet: 3/4"

MANUFACTURING AND TESTING:

This unit is manufactured in Sparta, Tennessee, USA. Each unit passes a through quality control review and is tested for proper operation prior to shipping. This unit is manufactured to meet or exceed the following certifications: Plumbing IAPMO Z124-2011, CSA B45.5-11 / Electrical UL 1795, CSA STD C22.2 NO. 218.2

WARRANTY:

Please reference section 5 for complete warranty details.

Using the Tub

Operating Instructions:

- To open the door, pull upward on door handle
- Step inside tub and lower yourself to the contoured seat.
- Pull door shut, grasp handle and push down until the door is in the locked position.
- Turn the diverter lever towards the tub spout and turn on the water. Check the temperature with your hand as you fill tub, adjust the temperature accordingly.
- Insert the drain plug or close the drain using the cable drain knob (if equipped)
- Fill the tub to the desired level.
- To use the shower wand, turn the diverter lever towards the shower wand until the water comes out of the shower wand.
- When finished bathing, pull the drain plug or open the drain using the cable drain knob (if equipped)
- When the tub is empty, open the door and exit the tub.



TEMPERATURES OVER 110 DEGREES FAHRENHEIT CAN SCALD!

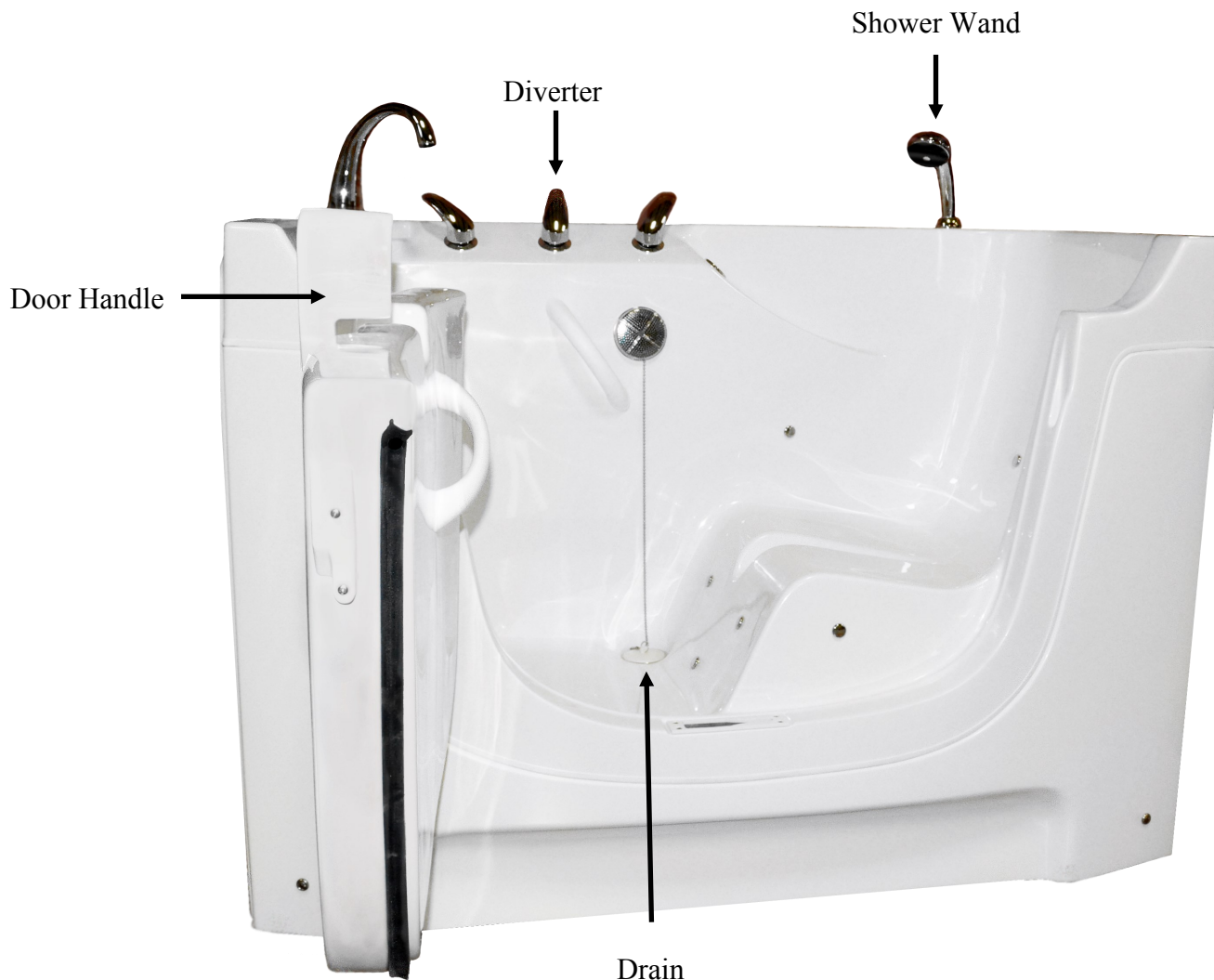

Using the Tub

AIR SPA (if equipped with Touch / Keypad)

- ON/OFF
 - 1st press: Blower turns on
 - 2nd press: Blower turns off
- BLOWER SPEED VARIATION
 - 1st press: Press and hold to increase the blower speed, release at desired speed.
 - 2nd press: Press and hold to decrease the blower speed, release at desired speed.
- PULSATION MODE
 - 1st press: Wave - Speed will vary gradually from maximum speed to minimum speed.
 - 2nd press: Pulse - Speed will go from minimum to maximum at no in between speeds.
 - 3rd press: Motor returns to full maximum speed.

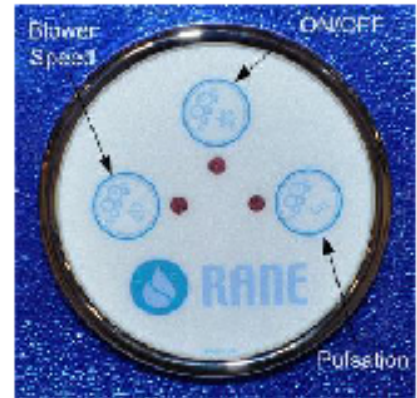

AIR SPA (if equipped with chrome High-Rise Button)

- ON/OFF BUTTON
 - 1st press: Blower turns on at high speed
 - 2nd press: Blower changes to low speed
 - 3rd press: Blower turns off
- *An automatic drying cycle will start 10 minutes after the blower is turned off and run for 1 minute. If using the Touch / Keypad, the ON/OFF button will blink (red LED) indicating the drying cycle is triggered.*



WHIRLPOOL (if equipped)

- ON/OFF BUTTON
 - 1st press: Pump starts
 - 2nd press: Pump stops
- AIR CONTROL
 - Turn Clockwise: Amount of air mixed with water will decrease (-)
 - Turn Counterclockwise: Amount of air mixed with water will increase (+)



Using the Tub

AROMATHERAPY (if equipped)

1. Remove chrome cap and add 2 or 3 drops of your choice of essential oil to 1 ounce of water into the diffuser.
2. Turn on by pressing the On / Off button on the touch / keypad.
3. Once turned on, the diffuser projects the natural flavor of the essential oil into the ambient air for approximately 20 minutes.

* *Do not pour essential oils directly into the diffuser, always mix with water. 2 to 3 drops of essential oil to 1 ounce of water.*

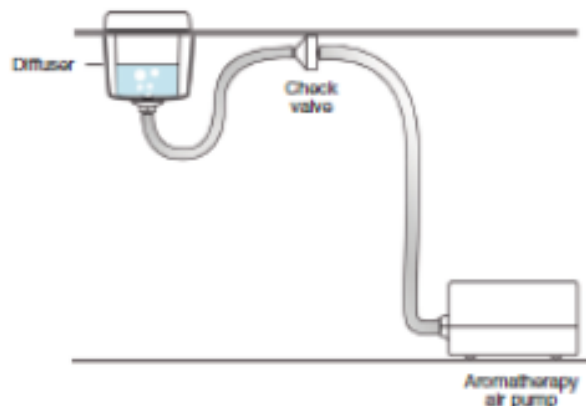

CHROMATHERAPY (if equipped)

• ON/OFF BUTTON

- Press 2x times quickly within 3 seconds: Light turns on and will change to the Rainbow Cycle (low speed).
- Press 3x times quickly within 3 seconds: Light turns on and will change to the Rainbow Cycle (high speed).
- Press and hold for 2 seconds: Light turns off



* *Rainbow Cycle: Light cycles through all 7 colors continually.*

To have one color continually or scroll through and choose a specific color;

- Press the On/Off Button 1x (pause at least 3 seconds between each press)
- 1st press: White
- 2nd press: Turquoise
- 3rd press: Blue
- 4th press: Magenta
- 5th press: Red
- 6th press: Orange
- 7th press: Yellow
- 8th press: Green



On / Off Button

Pre-Installation Drawings and Dimensions

FRONT VIEW

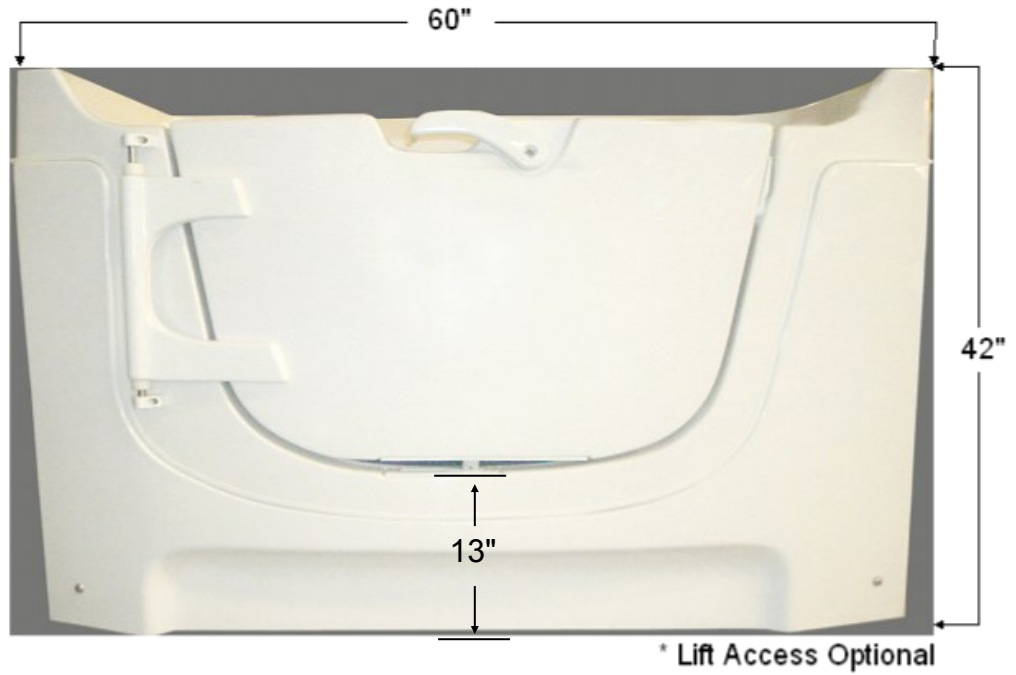

Vertical dimensions are with the tub in the lowest position. The seat height is 20.5". If legs are extended and tub is raised, adjust the dimensions accordingly

TOP VIEW

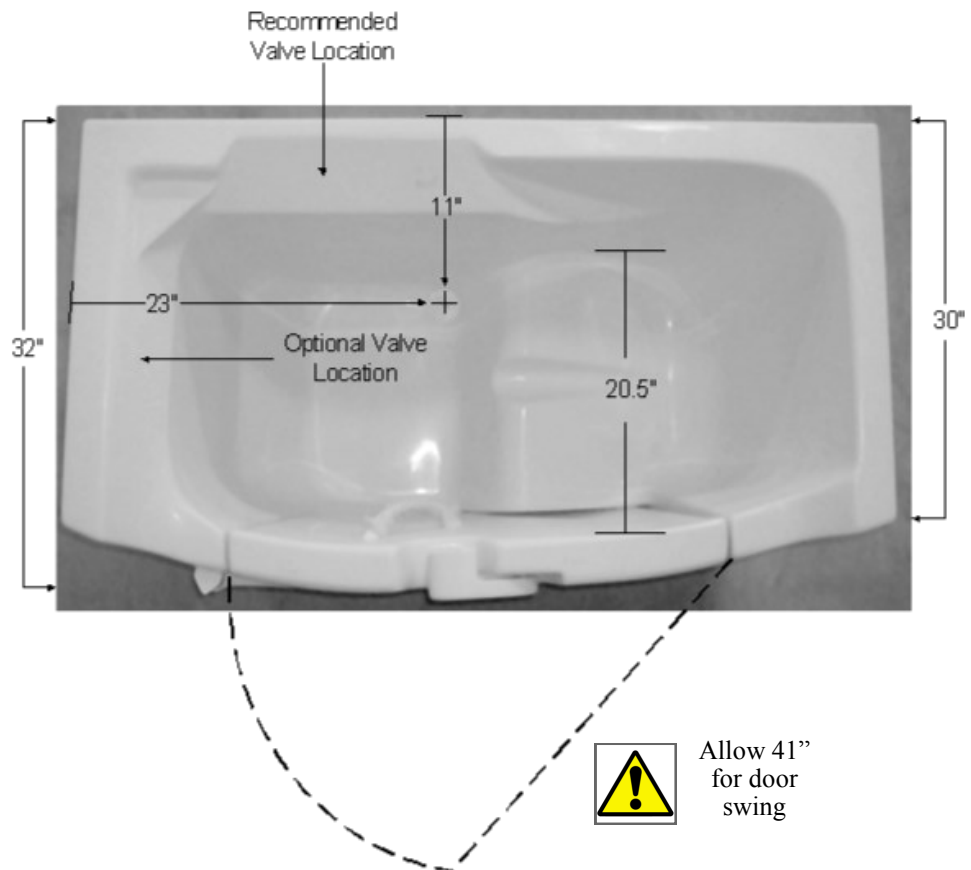

Pre-Installation Drawings and Dimensions

PLUMBING VIEW



Vertical dimensions are with the tub in the lowest position. If legs are extended and tub is raised, adjust the dimensions accordingly

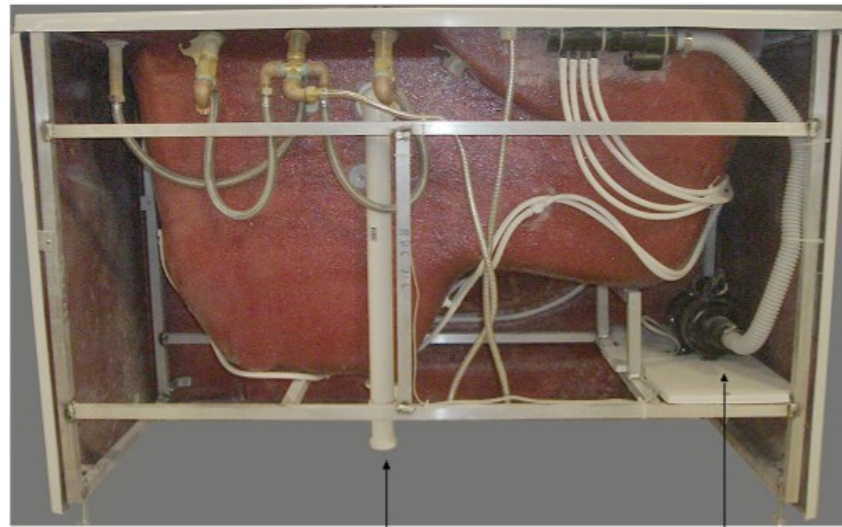

1.5" Sanitary Tee
(6" from floor)

Blower

BOTTOM VIEW



Adjusting tub too high during leveling will leave gap between front tub skirt and floor.

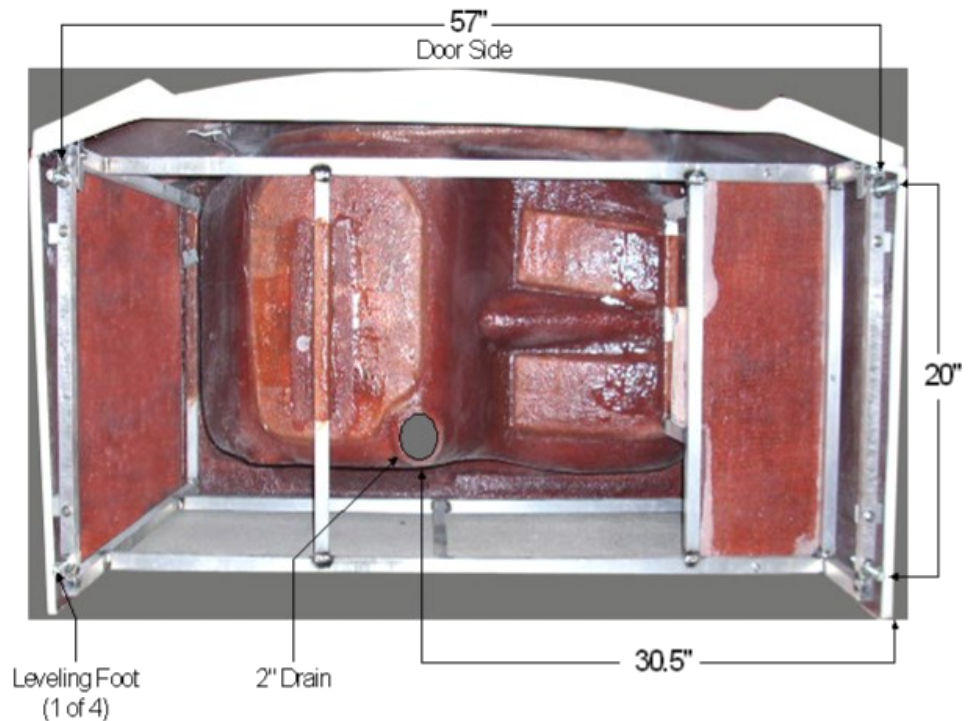

Pre-Installation Drawings and Dimensions

Room Location Options



Left Corner
Left Hinge Suggested

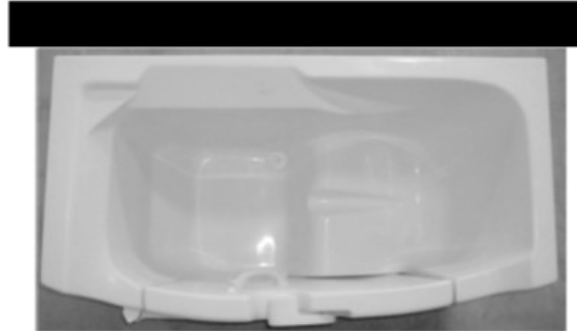

Mid-Wall
Left or Right Hinge

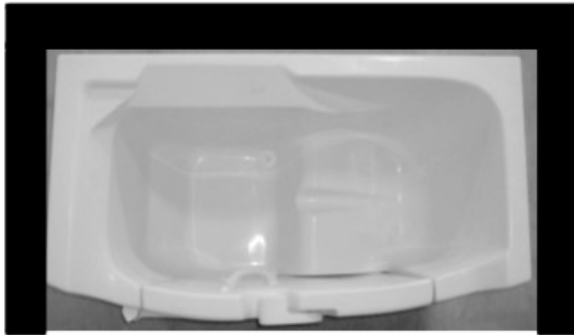

Alcove
Left or Right Hinge



Right Corner
Right Hinge Suggested



Full Height-Regular Wall

Installing the Tub

The RH6 is designed to be installed as a freestanding unit or built into an alcove. Several items of precaution should be taken during installation:

- **USE THIS PRODUCT ONLY FOR ITS INTENDED USE AS DESCRIBED FURTHER IN THESE USE THIS PRODUCT ONLY FOR ITS INTENDED USE AS DESCRIBED FURTHER IN THESE INSTRUCTIONS.**
- **DURING CONSTRUCTION, THE TUB'S SHELL IS VULNERABLE TO DAMAGE CAUSED BY FALLING OBJECTS. DO NOT STAND IN THE TUB FOR INSTALLATION.**
- **NEVER STORE CONSTRUCTION MATERIALS INSIDE THE TUB.**
- **PRINTED DIMENSIONS ARE FOR REFERENCE ONLY. ACTUAL MEASUREMENTS SHOULD BE TAKEN FROM THE TUB.**
- **THE TUB MUST BE WATER TESTED FOR LEAKS BEFORE THE TUB IS COMPLETELY ENCLOSED AND INSTALLED.**

Step #1: Determine final location and review framework for the unit. If installing into an “alcove” type installation, tub should be able to slide into final area without binding. Install rough-in plumbing and electrical hook-ups according to relevant building codes and regulations. Please review Section 3 for rough-in dimensions and allow for spacing as listed, plus any requirements for lifting devices.



Check all applicable building codes. All electrical and plumbing work must be performed by qualified personnel!

Step #2: Remove all packing material and cardboard from the unit. Set aside accessory box which was shipped inside the tub. Remove tub from pallet. Make sure the door is in the closed position for installation. This will allow for proper installation and help maintain the true shape of the tub unit itself.

Step #3: Slide tub into place to verify there are no issues between connections and tub. Level the tub in its final location. Then slide the tub back.

Step #4: Level the unit by turning the adjustable legs to raise or lower the unit. This should be done before doing anything else. Check to see that the unit is level by using a 4' level across the back and side of the tub.

Step #5: Clean water lines of debris prior to connection. Valves, shower heads, and accessories may become clogged or damaged if the lines are not clear. *Warranty does not cover damage caused by debris in the water lines.*

Step #6: Connect the hot and cold water inlet hoses to facility plumbing. Make sure that the hose screens are present (see below) and the hoses are not bent or kinked. The threaded connections are NOT “hose thread”, but rather “National Pipe Thread” (NPT).

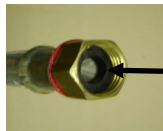

Make sure hose screens is present and inserted in hose end properly

Step #7: Set tub back into place, re-check level.

Step #8: If tub has an air spa blower or whirlpool pump, plug the electrical cord into the GFCI outlet.

Step #9: Attach any accessories, including shower wand and disinfect hose assembly. The shower hose is concealed inside tub, and can be pulled out.

Step #10: Test unit for proper operation. Be sure to clean inside of tub prior to filling unit. Check the unit for any leaks.

Step #11: Remove any installation labels and directions. Clean tub and prepare for daily use with warm water and non-abrasive cleaner.

MANUFACTURERS LIMITED WARRANTY

FOR WARRANTY CLAIMS OR INFORMATION, PLEASE CONTACT THE MANUFACTURER'S AUTHORIZED DEALER OR DISTRIBUTOR FROM WHOM THE PRODUCT WAS PURCHASED.

Manufacturer's product is warranted to be free from defects in materials and workmanship for a period of **five (5) years** for external finishes and composite shell, **three (3) years** for all moving and stationary parts, including but not limited to, valves, air spa blower, whirlpool pumps, actuators, door mechanisms, hinges, gauges, thermometers, and **Lifetime** for the door seal. **Shower and disinfectant hoses, handheld shower wands, and disinfectant spray wands are excluded from this warranty.**

Commencement of Warranty Period

Warranty commences on the date of shipment to Manufacturer's Authorized Dealer or Distributor.

Repair or Replacement

During the warranty period, Manufacturer will repair or replace any defective parts or portion thereof returned by Manufacturer's Authorized Dealer or Distributor if Manufacturer determines was defective due to faulty materials or workmanship. The Manufacturer's Authorized Dealer or Distributor must obtain a Return Goods Authorization (RGA) number from Manufacturer. **The Manufacturer's Authorized Dealer or Distributor will pay all related labor and return costs incurred in the replacement, installation, or repair of the defective parts or portion thereof to Manufacturer.** Manufacturer retains the exclusive right to repair or replace the defective products or parts or portion thereof at its sole discretion. In the event that it is determined that the cost of warranty repairs and/or parts is excessive, Manufacturer may require the Manufacturer's Authorized Dealer or Distributor to provide a written report and pictures of defect for review.

Disclaimer and Limitation of Remedies

The warranties and remedies contained herein are exclusive and in lieu of all other warranties express or implied or statutory, including any liability arising under any warranty of merchantability or fitness for a particular purpose, statutory or otherwise. In no event shall Manufacturer be liable for any incidental, special, indirect or consequential damages, whether resulting from the use, misuse, or inability to use this Product or defects in the Product. Warranty of parts subject to "normal wear and tear" (i.e. cushions, pads, lap and shoulder belts, shower wands, and hoses) are not covered under this warranty except as it applies to the defects in materials and workmanship.

Voiding of Warranties

The warranty does not cover products or parts thereof that have been subjected to abuse, misuse, neglect, unauthorized alteration or repair, damage during installation, or improper installation as per the instructions provided by Manufacturer.

Maintenance and Adjustments

Door Adjustments

If door is not aligned in tub rim and seal area;

1. Loosen 6 door hinge bolts with a #3 Phillips screwdriver.
2. Adjust door by applying pressure to the middle of the door. While pressure is on middle of door pay particular attention to height of left and right sides of door in relationship to top rim of tub.
3. Re-tighten screws and verify door operation.

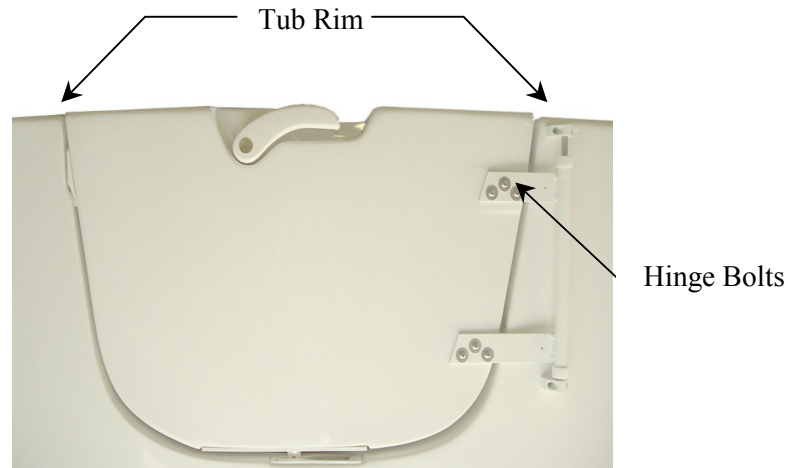

Front View of Door

If door is still leaking, you may need to adjust the door tension;

1. Un-latch and open the door.
2. Locate and loosen screws holding the knuckles onto the latching bar.
3. Turn the set screw at end of lock slide counterclockwise to raise the latching knuckles **1/8" at a time.**
4. Re-test door latching operation and check for leaks.
5. If no leaks, tighten screws holding knuckles. If door still leaks, repeat steps 3-5.

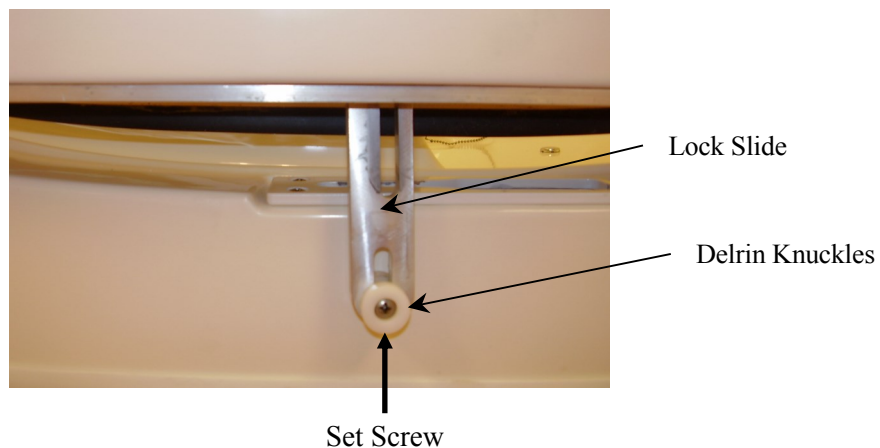

Maintenance and Adjustments

Replacing Door Mechanism

To replace complete door mechanism (See page 8.2 for mechanism and parts).

1. Unlatch and swing the door open.
2. Remove the hinge cover and outline door location on hinge with pencil. This will assist with re-installing the door in the same location.
3. Remove the (6) hinge bolts and remove door from unit.
4. On the door, remove handle button, and remove screw with a Phillips screwdriver.
5. Remove the (2) small screws holding the aluminum outside pin locator bushing.
6. Remove the (4) screws located on the bottom of door that holds the mechanism in the door.
7. Pull the door mechanism out from the bottom of the door.
8. Install new mechanism, and reassemble the door to the tub.
9. Test door for leaks and adjust if necessary.

Door Handle

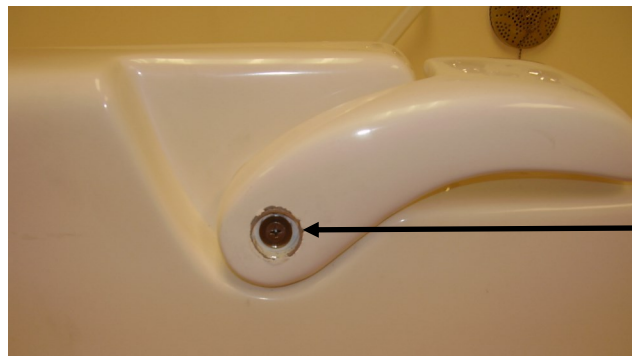

Remove screw, handle,
and white bushing

Bottom of Door



Remove 4 screws

Maintenance and Adjustments

Replacing Door Seal

Contents of Door Seal Kit

- . Instructions
- . Door Seal
- . Two (2) Black Push Pins

Instructions

1. Remove existing seal from the door by removing pushpins and peeling off seal.
2. Remove existing glue from door surface with solvent (Lacquer Thinner).
3. Using a paint brush, apply an even coat of glue to both the rough surface of seal and surface on the door.
4. Allow the glue on both surfaces to skin over (approximately five (5) minutes).
5. Beginning at one end of the seal, carefully place the seal into seal area of door taking care to make good contact between the door and seal. Be sure that the wide flat portion of seal is positioned as shown.

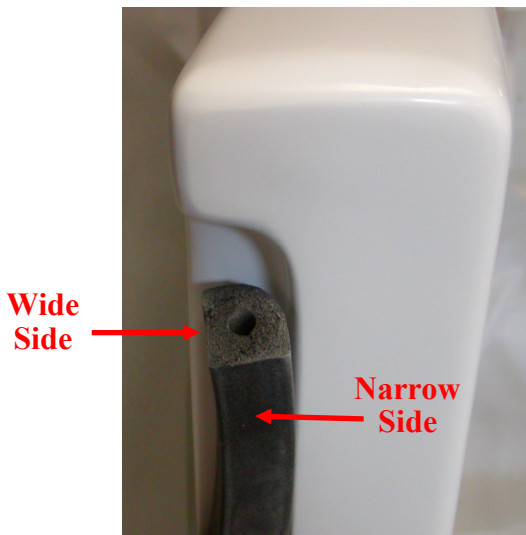

Correct Positioning



Incorrect Positioning



Incorrect Positioning

6. Use masking tape as necessary to help hold seal in place.
7. When entire seal is in place, taper ends as needed for proper fit and insert push pins at both ends of doors.
8. Use lacquer thinner on a towel to clean excess glue off the door surface.
9. Allow the glue to set for at least two (2) hours before the first use.



NOTE: THE USE OF PETROLEUM BASED CLEANERS OR LUBRICANTS WILL CAUSE RUBBER DOOR SEAL TO FAIL. TO CLEAN AND MAINTAIN SEAL, USE MILD SOAP AND WATER OR PRODUCTS DESIGNED SPECIFICALLY FOR RUBBER PRODUCTS.

Maintenance and Adjustments

Routine Maintenance

Please contact the Authorized Dealer or Distributor from whom the Product was purchased for periodic updates to this schedule.

Model # _____

Serial # _____

Check List	Monthly	3 Months	6 Months	Yearly
Check door seal for wear			X	
Check door for alignment			X	
Check hoses and connections			X	
Clean door seal	X			
Verify air blower functions and controls work properly			X	
Verify whirlpool function and controls			X	
Clean whirlpool suction fitting inlet		X		
Check GFCI			X	
Check to make sure access panels are secured			X	
Check diverter, hot, and cold handles to be secure and not loose			X	
Clean hot and cold water inlet screens			X	

Troubleshooting

Problem / Issue	Check	Action / Solution
Door is Leaking	Check door seal	Re-attach door seal if loose or replace if damaged. Go to Section 6 (Maintenance and Adjustments)
	Check door positioning	Align door. Go to Section 6 (Maintenance and Adjustments)
	Check door latching knuckle	Adjust door tension. Go to Section 6 (Maintenance and Adjustments)
Water too hot or too cold	Check hose washer / screen in end of supply hoses	Remove and check for debris or build-up, clean or replace if needed
	Check hot and cold supply lines for kink(s) or damage	Remove kink(s) or replace if needed
	Check if water supply dynamic pressures are within 10% of each other	Consult with a local Plumber
Valve package not working properly (ie. hot and cold levers, diverter, tub-fill)	Check lever(s)	Tighten set screw on lever(s) (Go to Section 8.1)
	Check cartridges (hot, cold, and diverter valves)	Replace cartridges if needed (Go to Section 8.1)
Door swings open or closes by itself	Check if tub is level	Adjust feet and level the tub
	Check door positioning	Align door. Go to Section 6 (Maintenance and Adjustments)
Door will not open or close properly	Check door seal for soap scum or mildew build-up	Clean with mild soapy water and let dry, then put baby powder on the seal.
	Check door positioning	Align door. Go to Section 6 (Maintenance and Adjustments)
	Check door latching knuckle	Adjust door tension. Go to Section 6 (Maintenance and Adjustments)
Air Spa not working properly (if equipped)	Check if plugged into outlet and/or damage to the electrical cord	Plug-in and/or replace the electrical cord if needed
	Check if GFCI outlet is working properly	Reset GFCI outlet / breaker
	Check gray hose for either kink(s) or has come off the air spa motor or manifold	Remove kink(s) or re-attach gray hose to air spa motor or manifold by tightening the hose clamps
	Check for User error	Go to Section 2 (Using the Tub)
Whirlpool not working properly (if equipped)	Check if plugged into outlet and/or damage to the electrical cord	Plug-in and/or replace the electrical cord if needed
	Check if GFCI outlet is working properly	Reset GFCI outlet / breaker
	Check suction fitting inlet	Clean and/or remove obstruction (hair, build-up, or debris)
	Check for User error	Go to Section 2 (Using the Tub)
Aromatherapy not working properly (if equipped)	Check if GFCI outlet is working properly	Reset GFCI outlet / breaker
	Check for User error	Go to Section 2 (Using the Tub)
Chromatherapy not working properly (if equipped)	Check if GFCI outlet is working properly	Reset GFCI outlet / breaker
	Check for User error	Go to Section 2 (Using the Tub)

Parts (Door)

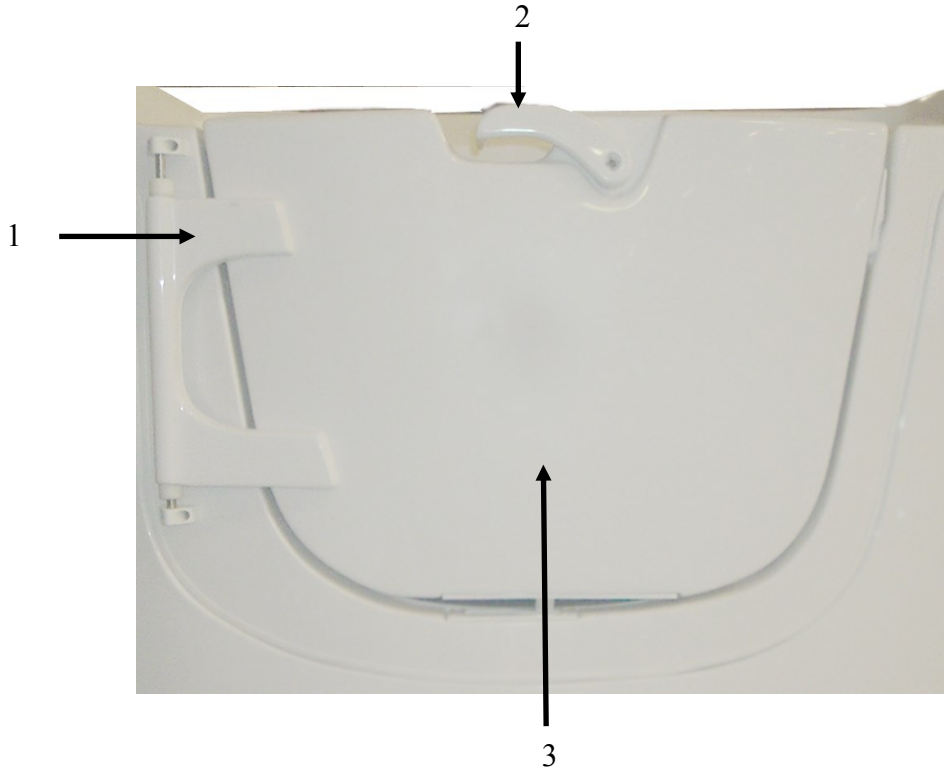

<u>#</u>	<u>Part #</u>	<u>Description</u>
1	HC	Hinge Cover, acrylic * <i>specify left or right hinge</i>
2	3416+H	Door Handle, RH w/ Aluminum Pin, RH6 (includes hardware)
2	3411+H	Door Handle, LH w/ Aluminum Pin, RH6 (includes hardware)
3	OSDL	Left Hinge Door, Complete (RH6)
3	OSDR	Right Hinge Door, Complete (RH6)

** The complete door assembly includes door, door mechanism, and door handle*

Parts (Door Mechanism)

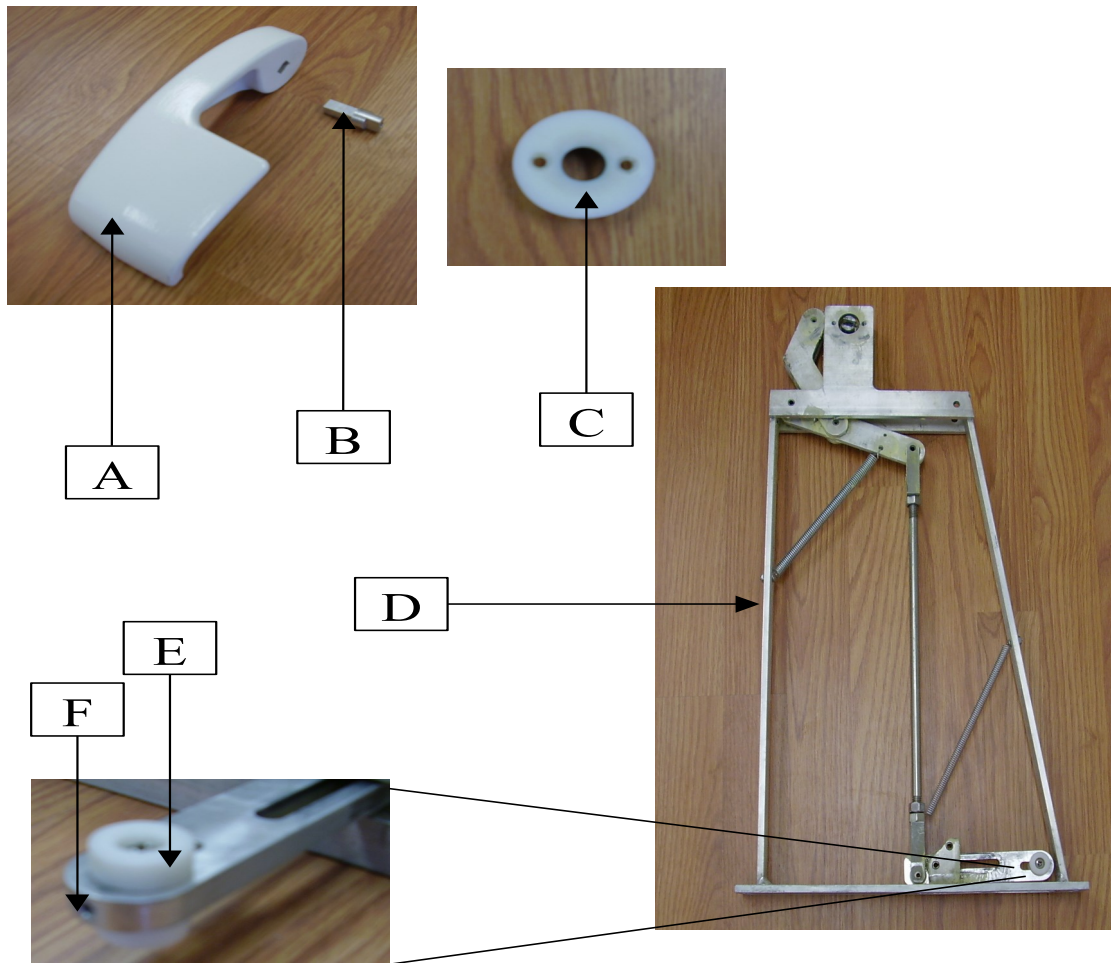

<u>#</u>	<u>Part #</u>	<u>Description</u>
A/B	3416+H	Door Handle, RH w/ Aluminum Pin, RH6 (includes hardware)
A/B	3411+H	Door Handle, LH w/ Aluminum Pin, RH6 (includes hardware)
C	3245	Outside Delrin Bushing
D	DOOR MECH	Door Mechanism (RH6) * <i>specify left or right hinge</i>
E	3215	Delrin Knuckle, Door Mechanism (incl. 10-24 x 7/8" pan head screw)
F	1040	Set Screw, 8-32 x 3/8" (Delrin Slide)

Parts (Door Hinge)

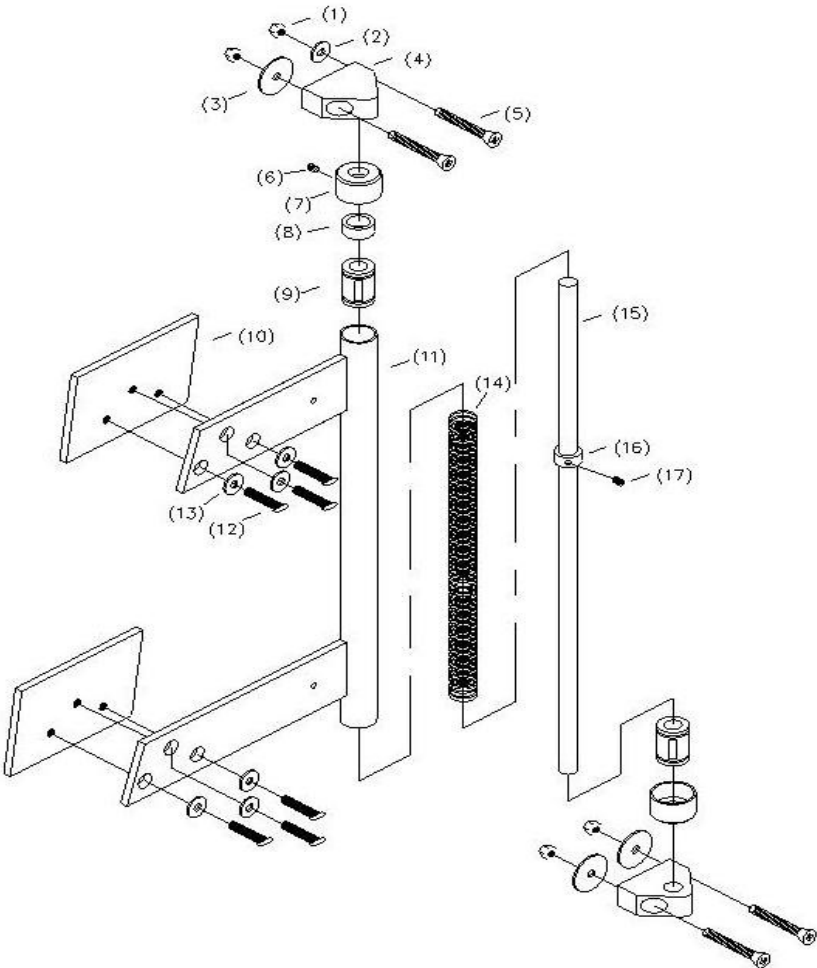

<u>#</u>	<u>Part #</u>	<u>Description</u>
4	3381	Hinge Rod Retainer / Blocks, Each
	3336+H	Complete Hinge Assembly, Right Hinge (RH6)
	3341+H	Complete Hinge Assembly, Left Hinge (RH6)

PARTS (Deck Mount Plumbing Package)



BREAK DOWN Component Parts List

#	PARTNAME	QTY
1	LEVER HANDLE	3
2	CARTRIDGE RETAINING NUTS	2
3	FLANGE STEP W/ RUBBERRING	2
4	HOT AND COLD CARTRIDGES	1 ea.
5	METAL WASHER	2
6	LOCK NUT	2
7	HOT AND COLD VALVES	1 ea.
8	SPOUT W/ SHANK	1
9	SPOUT RING	1
10	METAL WASHER	1
11	LOCK NUT	1
12	HOSE	2
13	TRANSFER VALVE SET	1
14	HAND SHOWER HOLDER ASSEMBLY	1
15	45 DEGREE ELBOW	1
16	HAND SHOWER	1

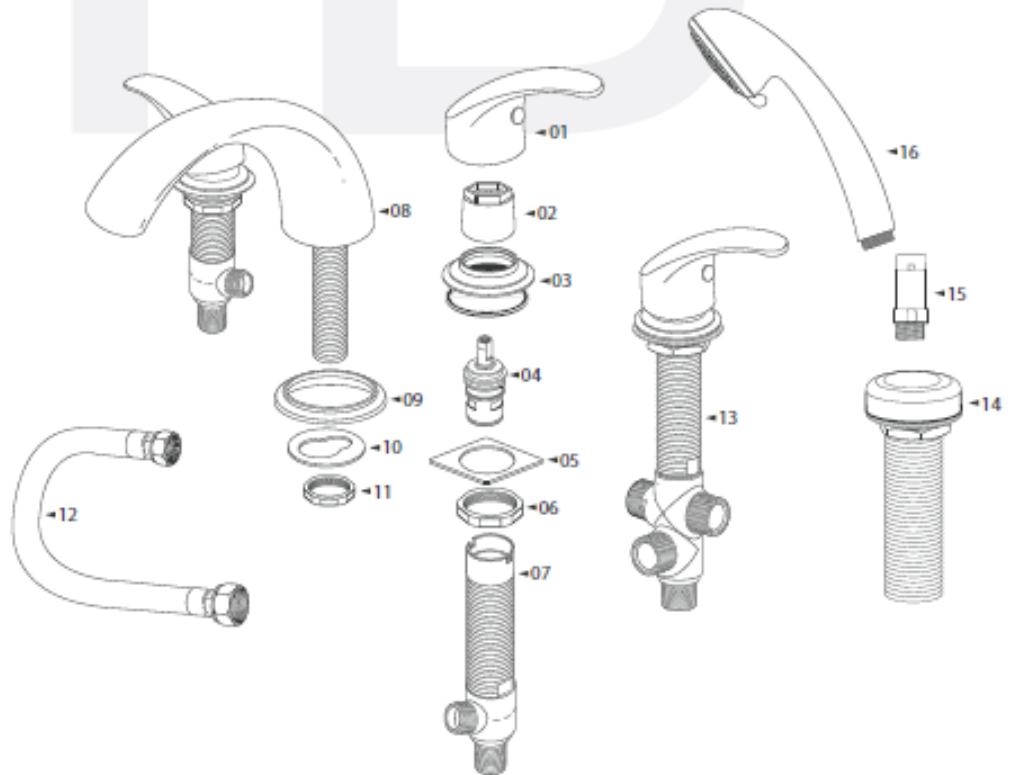

#	Part #	Description
1	3743	Lever Handle
4	3753	Cartridge (Cold Valve)
4	3754	Cartridge (Hot Valve)
14	1865	Deck Mount Shower Wand Holder, chrome
15	1866	45° Elbow w/ backflow prevention, chrome
16	1895	Shower Wand, chrome

Parts (Aromatherapy)

COMPONENTS

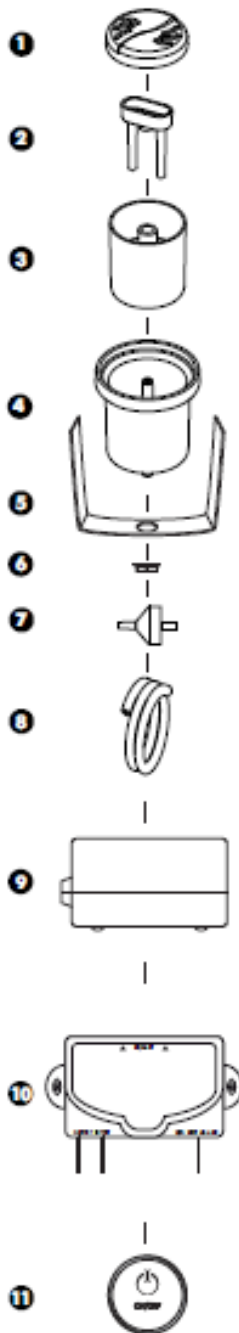

#	Part #	Description
1	3425	Cap, chrome
2	3758	Aroma Tubes
3	3759	Internal Bowl
7	3428	Check Valve, 1/8"
9	3433	Air Pump w/NEMA plug
11	3431	Touch / Keypad

INSTALLATION

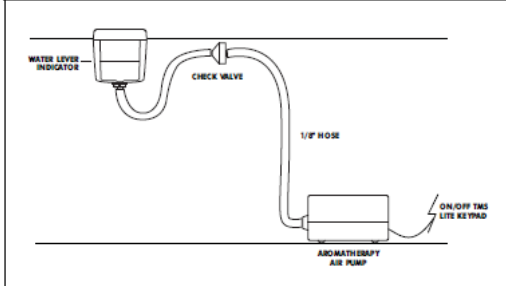

The system works using an air pump which leads the air towards the receptacle filled with water added with some essential oil drops.

1: Cap	AROMA-CAP-**
2: Tubes	AROMA-TUBES
3: Internal container	AROMA-BOL-INT
4: External container	AROMA-BOL-EXT
5: Bracket	BRACKET-AROMA
6: Lock nut	LOCKNUT-1/4
7: Check valve 1/8"	CH-VALVE-1/8-AROMA
8: 5' hose 1/8"	TUYAU-1/8 AIRPUSH 5'
9: Aromatherapy air pump	AROMA-POMPE-N
10: TMS Lite electronic control	IC-TMSPT-120/60-002-N-N-12"
11: On/Off TMS Lite keypad	CG-TMS1 -XR1CC01-**

Parts (Chromatherapy)

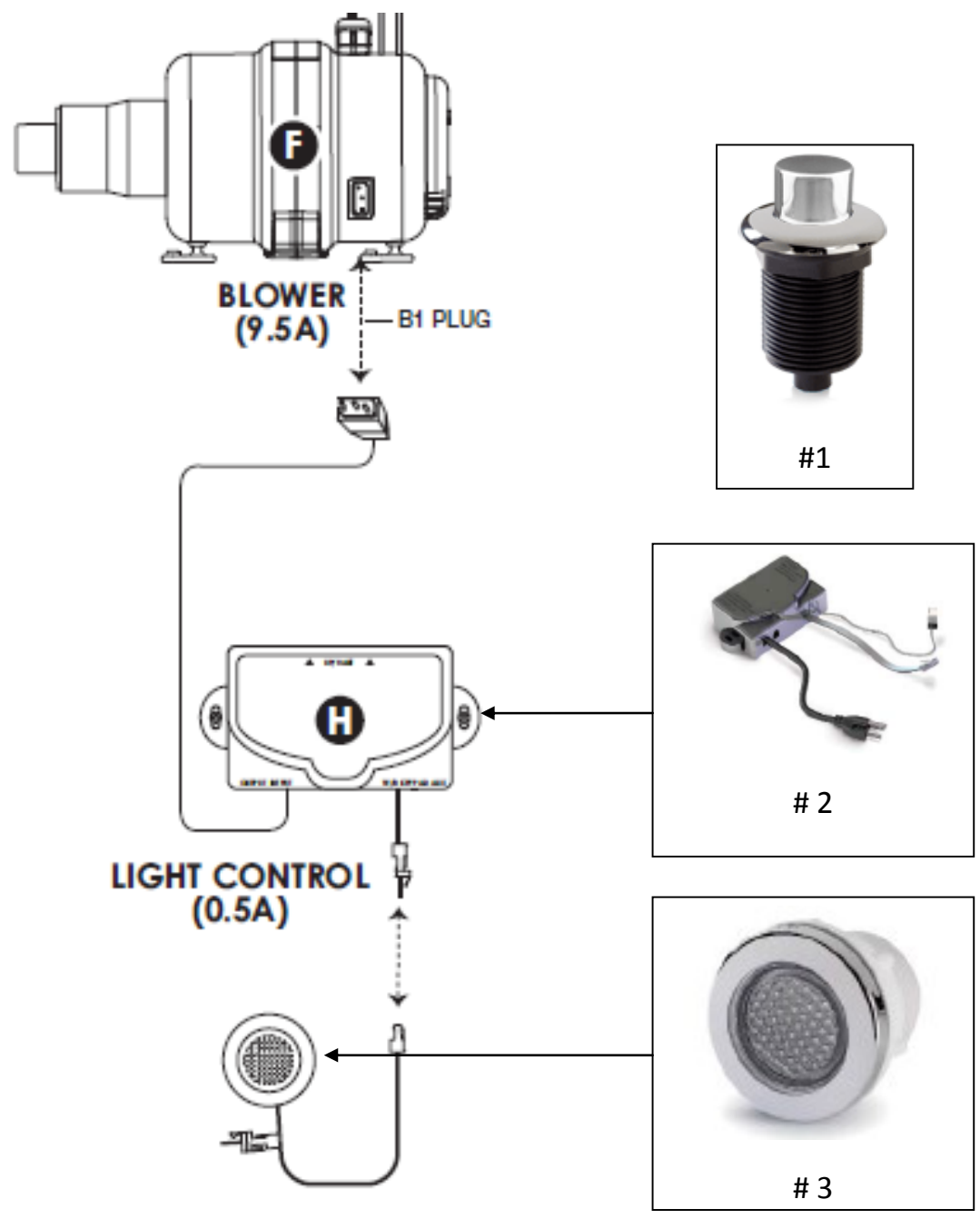

#	Part #	Description
1	3716	Air Switch, High-Rise Button, chrome (Off / On)
2	3437	Control Box
3	3436	Mini-Light, 9 LED Bulb (includes Round Flange and Cable)